

**Ewig**  
for import car

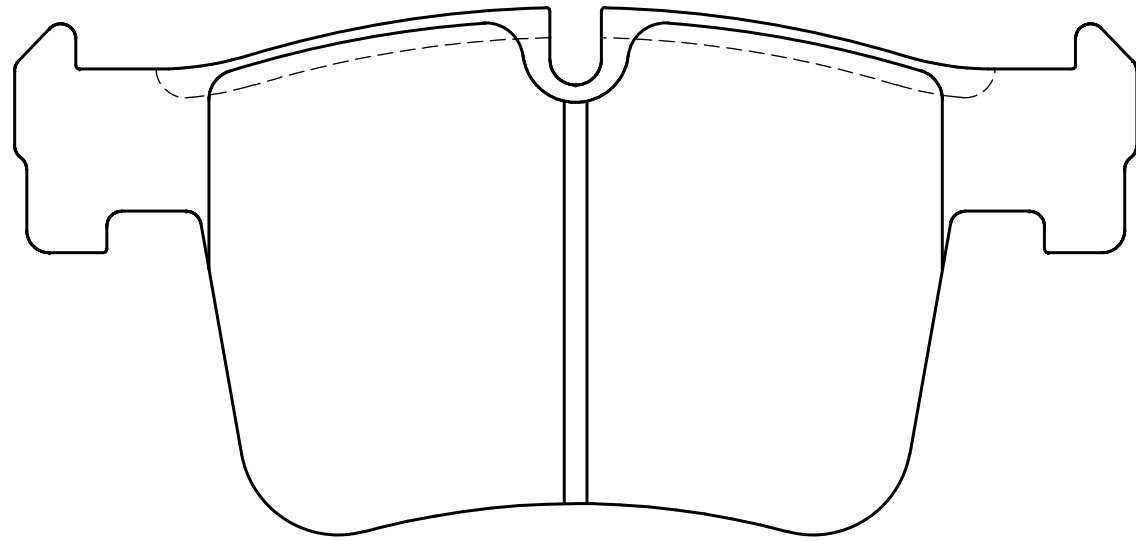

69.9

148.4

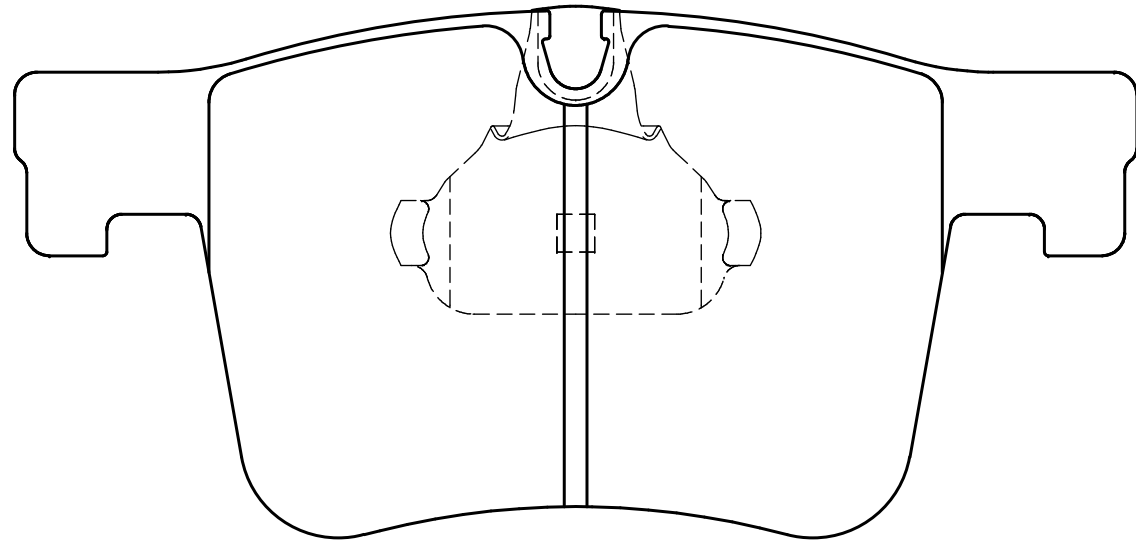

69.9

**Thickness : 19.5**

**Part No : EIP212**