

**Ewig**  
for import car

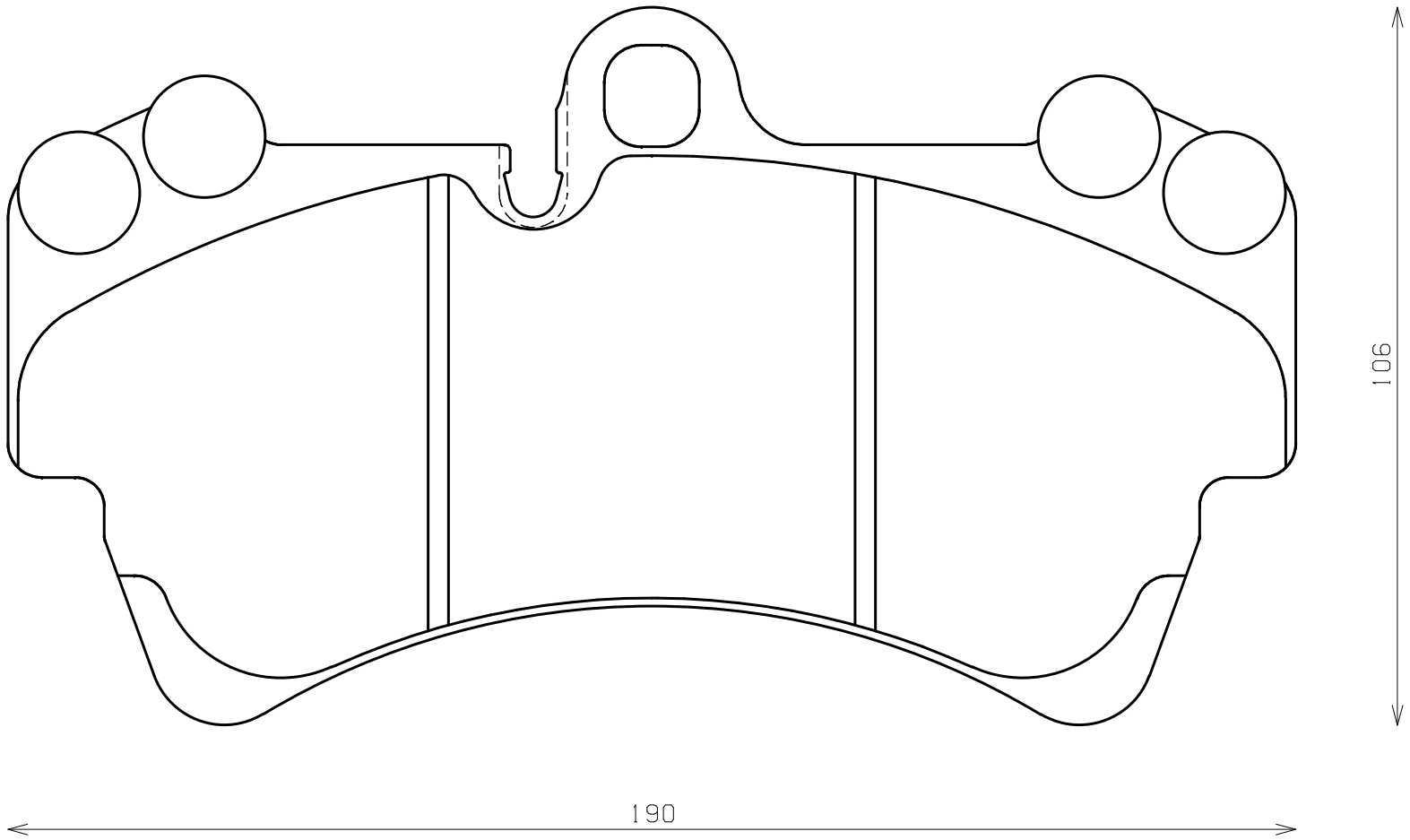

**Thickness : 16.0**

**Part No : EIP165**